



Quidway S5300 Series Ethernet Switches
V100R002C02

Quick Start

Issue 01
Date 2008-12-26
Part Number

Huawei Technologies Co., Ltd. provides customers with comprehensive technical support and service. For any assistance, please contact our local office or company headquarters.

Huawei Technologies Co., Ltd.

Address: Huawei Industrial Base
Bantian, Longgang
Shenzhen 518129
People's Republic of China

Website: <http://www.huawei.com>

Email: support@huawei.com

Copyright © Huawei Technologies Co., Ltd. 2008. All rights reserved.

No part of this document may be reproduced or transmitted in any form or by any means without prior written consent of Huawei Technologies Co., Ltd.

Trademarks and Permissions



and other Huawei trademarks are the property of Huawei Technologies Co., Ltd.

All other trademarks and trade names mentioned in this document are the property of their respective holders.

Notice

The information in this document is subject to change without notice. Every effort has been made in the preparation of this document to ensure accuracy of the contents, but the statements, information, and recommendations in this document do not constitute a warranty of any kind, express or implied.

Contents

About This Document.....	1
1 Quick Start.....	1-1
1.1 Introduction.....	1-2
1.1.1 Overview.....	1-2
1.2 S-switch Overview.....	1-2
1.2.1 Appearance of the S5300.....	1-2
1.3 Basic Configurations for the Device Management.....	1-3
1.3.1 Example for Configuring to Manage the S-switch Through Telnet.....	1-3
A Equipment Grounding Specifications.....	A-1
A.1 General Grounding Specifications.....	A-2
A.2 Grounding Specifications for an Equipment Room.....	A-2
A.3 Grounding Specifications for the Device.....	A-2
A.4 Grounding Specifications for Communications Power Supply.....	A-3
A.5 Grounding Specifications for Signal Cables.....	A-4
A.6 Specifications for Laying Out Grounding Cables.....	A-5
B Engineering Labels for Cables.....	B-1
B.1 Introduction to Labels.....	B-2
B.1.1 Label Materials.....	B-2
B.1.2 Type and Structure.....	B-2
B.1.3 Label Printing.....	B-4
B.1.4 Writing Labels.....	B-6
B.1.5 Affixing Labels.....	B-7
B.1.6 Contents of Engineering Labels.....	B-9
B.1.7 Precautions for Using Engineering Labels.....	B-10
B.2 Engineering Labels for Optical Fibers.....	B-10
B.2.1 Labels for the Optical Fibers Connecting Devices.....	B-10
B.2.2 Labels for the Optical Fibers Connecting the Device and an ODF.....	B-12
B.3 Engineering Labels for Network Cables.....	B-13
B.4 Engineering Labels for Trunk Cables.....	B-15
B.4.1 Engineering Labels for Trunk Cables Between Devices.....	B-15
B.4.2 Engineering Labels for Trunk Cables Between the Device and a DDF.....	B-17
B.5 Engineering Labels for User Cables.....	B-18

B.6 Engineering Labels for Power Cables.....	B-19
B.6.1 Engineering Labels for DC Power Cables.....	B-19
B.6.2 Engineering Labels for AC Power Cables.....	B-21

Figures

Figure 1-1 Side view of the S5328C-EI.....	1-2
Figure 1-2 Front view of the S5328C-EI-24S.....	1-2
Figure 1-3 Rear view of the S5352C-EI.....	1-3
Figure 1-4 Networking diagram of managing S-switch-A through Telnet.....	1-3
Figure B-1 Label for signal cables.....	B-3
Figure B-2 Power Cable Label.....	B-4
Figure B-3 Warning prompt before printing.....	B-5
Figure B-4 Writing direction of the characters on the label.....	B-6
Figure B-5 Text Area of the Label.....	B-7
Figure B-6 Label for Signal Cables.....	B-8
Figure B-7 Binding the Label for the Power Cable.....	B-9
Figure B-8 Printed parts on the label for signal cables.....	B-9
Figure B-9 Example of the label on the optical fiber between two devices.....	B-12
Figure B-10 Example of the label on the optical fiber between the device and the ODF.....	B-13
Figure B-11 Example of the label on network cables.....	B-15
Figure B-12 Engineering labels for trunk cables between devices.....	B-16
Figure B-13 Engineering labels for trunk cables between the device and a DDF.....	B-18
Figure B-14 Example of labels for user cables.....	B-19
Figure B-15 Example of the labels for DC power cables.....	B-20
Figure B-16 Labels for AC power cables.....	B-22

Tables

Table A-1 General Grounding Specifications.....	A-2
Table A-2 Equipment Grounding Specifications.....	A-3
Table A-3 Grounding Specifications for Communication Power Supply.....	A-3
Table A-4 Grounding Specifications for Signal Cables.....	A-4
Table A-5 Specifications for laying out grounding cables.....	A-5
Table B-1 Standard Typeface for Handwriting.....	B-6
Table B-2 Information on labels affixed to the fiber between two devices.....	B-10
Table B-3 Information on labels affixed to the fiber between the device and the ODF.....	B-12
Table B-4 Information on the Ethernet cables.....	B-14
Table B-5 Contents of engineering labels for trunk cables between devices.....	B-16
Table B-6 Contents of the labels for trunk cables between the device and a DDF.....	B-17
Table B-7 Contents of the engineering labels for user cables.....	B-18
Table B-8 Contents of the label.....	B-20
Table B-9 Label content.....	B-21

About This Document

Purpose

This part describes the organization of this document, product version, intended audience, conventions, and update history.

Related Versions

The following table lists the product versions related to this document.

Product Name	Version
S5300	V100R002C02

Intended Audience

The intended audiences of this document are:

- Installation engineers
- Commissioning engineers
- On-site maintenance engineers
- System maintenance engineers

Organization

This document consists of three chapters and is organized as follows.





Chapter	Description
1 Quick Start	This chapter describes the hardware and basic configurations of the device.

Chapter	Description
A Equipment Grounding Specifications	Grounding specifications include general grounding specifications, the grounding specifications for the equipment room, device, communication power modules, signal cables, signal cables, and the specification for laying out grounding cables.
B Engineering Labels for Cables	This chapter describes the engineering labels for optical fibers, Ethernet cables, and power cables.

Conventions

Symbol Conventions

The following symbols may be found in this document. They are defined as follows.

Symbol	Description
 DANGER	Indicates a hazard with a high level of risk which, if not avoided, will result in death or serious injury.
 WARNING	Indicates a hazard with a medium or low level of risk which, if not avoided, could result in minor or moderate injury.
 CAUTION	Indicates a potentially hazardous situation that, if not avoided, could cause equipment damage, data loss, and performance degradation, or unexpected results.
 TIP	Indicates a tip that may help you solve a problem or save your time.
 NOTE	Provides additional information to emphasize or supplement important points of the main text.

General Conventions

Convention	Description
Times New Roman	Normal paragraphs are in Times New Roman.
Boldface	Names of files, directories, folders, and users are in boldface . For example, log in as user root .
<i>Italic</i>	Book titles are in <i>italics</i> .
Courier New	Terminal display is in Courier New.

Command Conventions

Convention	Description
Boldface	The keywords of a command line are in boldface .
<i>Italic</i>	Command arguments are in <i>italics</i> .
[]	Items (keywords or arguments) in brackets [] are optional.
{ x y ... }	Optional items are grouped in braces and separated by vertical bars. One item is selected.
[x y ...]	Optional items are grouped in brackets and separated by vertical bars. One item is selected or no item is selected.
{ x y ... }*	Optional items are grouped in braces and separated by vertical bars. A minimum of one item or a maximum of all items can be selected.
[x y ...]*	Optional items are grouped in brackets and separated by vertical bars. Several items or no item can be selected.
&<1-n>	The parameter before the & sign can be repeated 1 to n times.
#	A line starting with the # sign is comments.

GUI Conventions

Convention	Description
Boldface	Buttons, menus, parameters, tabs, window, and dialog titles are in boldface . For example, click OK .
>	Multi-level menus are in boldface and separated by the ">" signs. For example, choose File > Create > Folder .

Keyboard Operation

Format	Description
Key	Press the key. For example, press Enter and press Tab .
Key 1+Key 2	Press the keys concurrently. For example, pressing Ctrl+Alt+A means the three keys should be pressed concurrently.
Key 1, Key 2	Press the keys in turn. For example, pressing Alt, A means the two keys should be pressed in turn.

Mouse Operation

Action	Description
Click	Select and release the primary mouse button without moving the pointer.
Double-click	Press the primary mouse button twice continuously and quickly without moving the pointer.
Drag	Press and hold the primary mouse button and move the pointer to a certain position.

Update History

Updates between document versions are cumulative. Therefore, the latest document version contains all updates made to previous versions.

Updates in Issue 01 (2008-12-26)

First commercial release.

1 Quick Start

About This Chapter

This section describes the hardware, installation procedure, and basic configurations of the device.

[1.1 Introduction](#)

[1.2 S-switch Overview](#)

[1.3 Basic Configurations for the Device Management](#)

This section describes the basic configurations for the device management such as configuring IP addresses, remote login, naming the device, and setting device time.

1.1 Introduction

1.1.1 Overview

1.1.1 Overview

The Quidway S5300series switches are a series of Layer 2 line-rate Ethernet switches. They are intelligent and manageable, and applicable to the environments where high performance, high port density, and installation easiness are required.

This document gives you an overview of the products and basic configurations for device management.

1.2 S-switch Overview

1.2.1 Appearance of the S5300

1.2.1 Appearance of the S5300

Appearance of the S5328C-EI

The case-shape chassis for the S5328C-EI is 1 U (1 U = 44.45 mm) high with the dimensions of 442.0 mm x 220.0 mm x 43.6 mm (width x depth x height). **Figure 1-1** shows the side view of the S5328C-EI.

Figure 1-1 Side view of the S5328C-EI



Appearance of the S5328C-EI-24S

The chassis of the S5328C-EI-24S is 1 U high with the dimensions of 442.0 x 420.0 x 43.6 mm (width x depth x height). **Figure 1-2** shows the front view of the S5328C-EI-24S.

Figure 1-2 Front view of the S5328C-EI-24S



Appearance of the S5352C-EI

The chassis of the S5352C-EI is 1 U high with the dimensions of 442.0 x 420.0 x 43.6 mm (width x depth x height). **Figure 1-3** shows the rear view of the S5352C-EI.

Figure 1-3 Rear view of the S5352C-EI



1.3 Basic Configurations for the Device Management

This section describes the basic configurations for the device management such as configuring IP addresses, remote login, naming the device, and setting device time.

1.3.1 Example for Configuring to Manage the S-switch Through Telnet

1.3.1 Example for Configuring to Manage the S-switch Through Telnet

Networking Requirements

As shown in **Figure 1-4**, S-switch-A is newly added to the network. S-switch-A and S-switch-B are connected through a trunk link. To enable the network administrator to manage S-switch-A remotely, you need to configure the Telnet service and set the device name on S-switch-A.

When the administrator logs in to S-switch-A through Telnet, ensure that the PC of the administrator and S-switch-A are reachable at the network layer.

Figure 1-4 Networking diagram of managing S-switch-A through Telnet

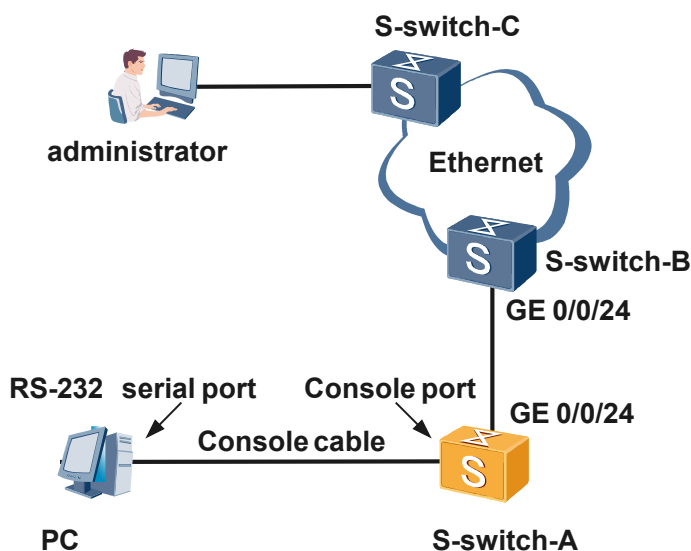

Configuration Roadmap

The configuration roadmap is as follows:

- Log in to S-switch-A through the console interface.
- Set the device name.
- Configure a management VLAN.
- On S-switch-A, set the type of the interface that connects S-switch-A and S-switch-B to trunk. Add the interface to the management VLAN in trunk mode.
- Configure the management IP address of S-switch-A.
- Configure the Telnet service.

Data Preparation

To complete the configuration, you need the following data:

- ID of the management VLAN
- Management IP address of S-switch-A
- Number of the interface that connects S-switch-A and S-switch-B on S-switch-A
- Authentication mode, user name, and password

Configuration Procedure

1. Log in to S-switch-A through the console interface.
2. Set the device name of S-switch-A.

```
<Quidway> system-view
[Quidway] sysname S-switch-A
```
3. Configure a management VLAN.

```
[S-switch-A] vlan 1
[S-switch-A-vlan1] description admin_VLAN
```
4. On S-switch-A, set the type of the interface that connects S-switch-A and S-switch-B to trunk. Add the interface to the management VLAN in trunk mode.

```
[S-switch-A] interface GigabitEthernet 0/0/24
[S-switch-A-GigabitEthernet0/0/24] undo port default vlan
[S-switch-A-GigabitEthernet0/0/24] port link-type trunk
[S-switch-A-GigabitEthernet0/0/24] port trunk allow-pass vlan 1
[S-switch-A-GigabitEthernet0/0/24] quit
```
5. Configure the management IP address of S-switch-A.

```
[S-switch-A] interface vlanif 1
[S-switch-A-Vlanif1] ip address 10.10.10.10 255.255.255.0
[S-switch-A-Vlanif1] quit
```
6. Configure the Telnet service. Adopt the AAA authentication mode, with the user name of **huawei** and the password of **huawei**.

```
[S-switch-A] aaa
[S-switch-A-aaa] local-user huawei password simple huawei
[S-switch-A-aaa] local-user huawei service-type telnet
[S-switch-A-aaa] local-user huawei level 15
[S-switch-A-aaa] quit
[S-switch-A] user-interface vty 0 4
[S-switch-A-ui-vty0-4] authentication-mode aaa
[S-switch-A-ui-vty0-4] quit
[S-switch-A]
```

7. Verify the configuration.

```
<S-switch-A> telnet 127.0.0.1
Trying 127.0.0.1 ...
Press CTRL+T to abort
Connected to 127.0.0.1 ...
*****
*           All rights reserved (2000-2007)           *
*   Without the owner's prior written consent,       *
* no decompiling or reverse-engineering shall be allowed. *
* Notice:                                             *
*   This is a private communication system.           *
*   Unauthorized access or use may lead to prosecution. *
*****

Login authentication

Username:huawei
Password:
Note: The max number of VTY users is 15, and the current number
      of VTY users on line is 3.
<S-switch-A>
```

Configuration Files

- S-switch-A

```
#
sysname S-switch-A
#
vlan batch 1
.....
#
interface Vlanif1
ip address 10.10.10.10 255.255.255.0
.....
interface GigabitEthernet0/0/24
port link-type trunk
port trunk allow-pass vlan 1
.....
aaa
local-user huawei password simple huawei
local-user huawei service-type telnet
local-user huawei level 15
authentication-scheme default
#
authorization-scheme default
#
accounting-scheme default
#
domain default
#
user-interface con 0
user-interface vty 0 4
authentication-mode aaa
```

A Equipment Grounding Specifications

This describes grounding specifications, including general grounding specifications, the grounding specifications for equipment rooms, devices, communication power modules, signal cables, and the specification for laying out grounding cables.

[A.1 General Grounding Specifications](#)

This describes the requirements of general grounding specifications in details.

[A.2 Grounding Specifications for an Equipment Room](#)

This describes the requirements for the grounding of the equipment room in details.

[A.3 Grounding Specifications for the Device](#)

This describes the requirements for the grounding of the device in details.

[A.4 Grounding Specifications for Communications Power Supply](#)

This describes the requirements for the grounding of communications power modules in details.

[A.5 Grounding Specifications for Signal Cables](#)

This describes the requirements for the grounding of signal cables in details.

[A.6 Specifications for Laying Out Grounding Cables](#)

This describes the requirements for laying out grounding cables in details.

A.1 General Grounding Specifications

This describes the requirements of general grounding specifications in details.

Table A-1 shows the general grounding specifications.

Table A-1 General Grounding Specifications

No.	Description
1	The design for grounding should follow the principles of equal voltage and equal potential. That is, the working grounding and protection grounding, including the shielded grounding and the lightning-proof grounding of the cable distribution frame are jointly grounded at the same group of grounding body.
2	The cabling racks, racks or shells, metal ventilation pipes, metal doors and windows in the equipment room should be grounded for protection.
3	The metal parts of the equipment which are neutral in normal conditions should be grounded for protection.
4	The grounding cable must be connected properly to the protection grounding bar of the equipment room.
5	Do not take other equipment as the component part of the grounding cable or electrical connection.

A.2 Grounding Specifications for an Equipment Room

This describes the requirements for the grounding of the equipment room in details.

The grounding resistance of a comprehensive communication building should be less than or equal to one ohm. The grounding resistance of an ordinary communication office should be less than five ohms. The grounding resistance in the area where earth resistance rate is high should be less than 10 ohms.

A.3 Grounding Specifications for the Device

This describes the requirements for the grounding of the device in details.

Table A-2 shows the equipment grounding specifications.

Table A-2 Equipment Grounding Specifications

No.	Description
1	All communication devices and auxiliary devices (such as mobile base stations, transmission and switching devices, power supply devices) in the equipment room should be grounded for protection. Connect all protection grounding for various devices jointly to a general grounding bar, and then to the same protection grounding bar in the room together with the protection ground (PGND) of the device.
2	The PGND of the equipment is shorted to the copper protection grounding bar provided by the user. The short-circuiting cable used should be an alternating yellow and green plastic insulating one with copper core, with cross-sectional area greater than 35 sq. mm.
3	There are grounding terminals and grounding flags at the lower part of the front door, rear door and side panel of the cabinet, connected to the grounding terminals of the cabinet framework through connection cables with cross-sectional area no less than 1.6 sq. mm.
4	Keep all metal components of the cabinet in good conductivity. No insulating coating should be sprayed on the connection part of the metal components.
5	Connect the cabinets in the same row closely by fastening captive screws and gaskets on the top of the cabinets. Do not spray coating into a rectangle area of 30 mm x 50 mm around the connection hole for captive bolt. Measures to prevent rust and corrosion must be taken for this area. Zinc electroplating with iridescent yellow chromate conversion coating should be applied to the gasket and nut to ensure sufficient electric contact.
6	When combining cabinets of the same type, short-circuiting cables are required to connect the grounding busbars (if any) of the cabinets. The cross-sectional area of the short-circuiting cable is 6 sq. mm and is less than 300 mm long. Connect the two ends of the short-circuiting cable respectively to the grounding busbar terminals of the neighboring cabinets and fix them firmly.

A.4 Grounding Specifications for Communications Power Supply

This describes the requirements for the grounding of communications power modules in details.

Table A-3 shows the grounding specifications for communication power supply.

Table A-3 Grounding Specifications for Communication Power Supply

No.	Description
1	The AC power supply system of the communication equipment room should adopt the TN-S power supply mode.

No.	Description
2	The inlet for the AC power cable at the equipment room should be equipped with a lightning protection device (C-level) with a nominal discharging current no less than 20 kA.
3	The protection ground for the power supply and that for communication equipment share the same group of grounding body. If the power supply and the equipment are in the same equipment room, try to use the same protection grounding bar for them.
4	Add lightning protection circuit for the AC power interface.
5	The anode of the -48 V DC power supply or negative pole of the 24 V DC power supply should be grounded at the output of the DC power supply.
6	The working ground and protection ground of the DC power supply equipment should use the same group of grounding body with the protection ground of the switching equipment. If the power supply and equipment are in the same equipment room, try to use the same protection grounding bar for them.
7	Add surge protection for the DC power interface.

A.5 Grounding Specifications for Signal Cables

This describes the requirements for the grounding of signal cables in details.

Grounding specifications for signal cables are shown in [Table A-4](#).

Table A-4 Grounding Specifications for Signal Cables

No.	Description
1	If there are digital trunks that connect the transmission equipment directly or indirectly to the wireless communication equipment in the station, install an E1 lightning protection device for the relative interface of the transmission equipment.
2	Equip the cable laid out outdoors with metal jacket, and well ground its two ends, or connect them to the protection grounding bar of the equipment room. For cables inside the equipment room, install lightning protection devices at the corresponding interface of the equipment. The protection grounding cable for the lightning protection devices should be as short as possible.
3	Both ends of the external conductor of the coaxial cable and those of the shielding layer of the shielded cable should have good electric contact with the metal shell of the equipment they connect to.
4	The incoming and outgoing signal cables to and from the office and the idle line pair inside the cable should be grounded for protection.
5	The Tone & Data Access (TDA) cable must pass the Main Distribution Frame (MDF) with security unit when going out the office. Its shielding layer should be connected to the protection ground of the MDF. The MDF should use the same group of grounding body with the cabinet.

No.	Description
6	The signal cables within the area of the communication office and mobile station should not be arranged aerially.

A.6 Specifications for Laying Out Grounding Cables

This describes the requirements for laying out grounding cables in details.

Table A-5 shows the cabling specifications for the grounding cable.

Table A-5 Specifications for laying out grounding cables

No.	Description
1	The grounding leading should not parallel or twist with the signal cable.
2	The grounding cable cannot be led in aerially, but should be buried in the earth globally or arranged indoor.
3	Do not connect to extend the protection grounding cable, or add any switch or fuse.
4	The protection grounding cable used should be an alternating yellow and green plastic insulating one with copper core.
5	The neutral line of the AC power cable cannot be connected with the protection ground of various transmission and communication equipment in the equipment room.
6	The length of the protection grounding cable should not exceed 45 m. The protection grounding cable should be as short as possible. When it is longer than 45 m, you can advise the user to replace the grounding bar nearby.

B Engineering Labels for Cables

This gives you an overview of engineering labels and describes the engineering labels for optical fibers, Ethernet cables, and power cables.

An engineering label serves as an identifier for on-site installation and maintenance after the installation. Labels on the cables facilitate correct and orderly connection of cables, and easy maintenance after installation.

Specialized for power cables and signal cables, the types of engineering labels are as follows:

- The signal cables include network cables, optical fibers, trunk cables, and user cables (excluding antenna feeders).
- The power cables include the AC power cables and DC power cables (excluding the power bus cable).

 **NOTE**

Fill in the label according to the user's requirements if the user needs an integrated description of the label. Make a relevant statement in the self-check report.

[B.1 Introduction to Labels](#)

This describes the material, types, structure, and contents of engineering labels, and how to print, fill in, and paste engineering labels, and the precautions for using engineering labels.

[B.2 Engineering Labels for Optical Fibers](#)

This describes the engineering labels for optical fibers, including the labels for the optical fibers between devices and the labels for the optical fibers between a device and an ODF.

[B.3 Engineering Labels for Network Cables](#)

This describes the applicable ranges and contents of the engineering labels for network cables and gives instances.

[B.4 Engineering Labels for Trunk Cables](#)

This describes the engineering labels for trunk cables, including the labels for the cables between devices and the labels for the cables between a device and an MDF.

[B.5 Engineering Labels for User Cables](#)

This describes the applicable ranges and contents of the engineering labels for user cables and provides examples.

[B.6 Engineering Labels for Power Cables](#)

This describes the engineering labels for power cables, including DC and AC power cables.

B.1 Introduction to Labels

This describes the material, types, structure, and contents of engineering labels, and how to print, fill in, and paste engineering labels, and the precautions for using engineering labels.

[B.1.1 Label Materials](#)

[B.1.2 Type and Structure](#)

[B.1.3 Label Printing](#)

[B.1.4 Writing Labels](#)

[B.1.5 Affixing Labels](#)

[B.1.6 Contents of Engineering Labels](#)

[B.1.7 Precautions for Using Engineering Labels](#)

B.1.1 Label Materials

Features:

- Thickness: 0.09 mm
- Color: chalk white
- Material: polyester (PET)
- Ambient temperature: -29°C to +149°C
- Compatible with laser printing and handwriting with oiliness markers
- Pass the UL and CSA authentication

B.1.2 Type and Structure

Label for Signal Cables

The label for signal cables is L-shaped with fixed dimensions, as shown in [Figure B-1](#).

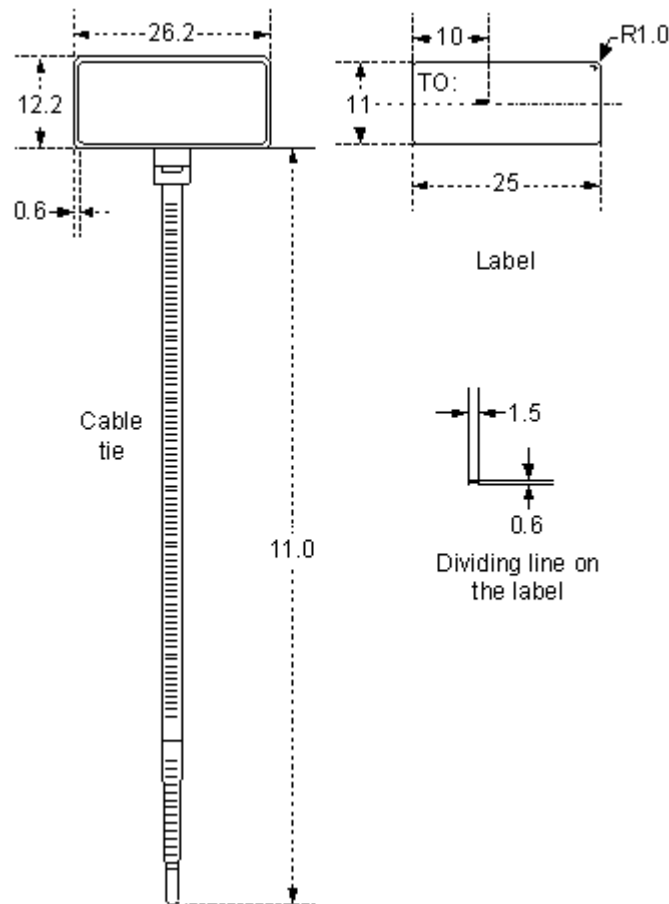
Figure B-2 Power Cable Label

B.1.3 Label Printing

The contents can be printed or written on the labels. Printing is recommended for the sake of high efficiency and eye-pleasant layout.

Template for the Printing

You must use a template to print labels. You can obtain the template through the following methods:

- Download the template from <http://support.huawei.com>.
- Obtain the template from the Huawei local office.

The templates are made in Microsoft Word and the following requirements should be met:

- When using the template, you can directly modify the contents on the template. The settings of centered characters, direction, and fonts should not be changed.
- When there are too many characters to be filled in, zoom out the characters, but make sure that the printouts are clear and legible.

Merging Cells in the Template

To merge two or more cells, do as follows:

1. Select **Edit/Select All**.
2. Select **Format/Borders and Shading/Borders**. Select **Box** tab and click **OK**.
3. Drag the mouse to select cells to be merged and select the **Table/Merge Cells**.

Requirements on the Printer

To print the labels, laser jet printer must be used, although there is no restriction on the model of the printer. Before printing the label, set up the page and try the printing.

1. Try the printing on ordinary paper with both blank sides. Cover the blank paper onto the whole page of label paper, and check whether the page setup conforms to the requirement.
2. Make sure the printer properties, such as "paper size" and "direction", have been set correctly.
 - If the printout conforms to the requirement, print it to label paper.
 - If the printout does not conform, adjust the page setup and try the printing again, until the correct printout is produced.

The method of adjusting the page setup is as follows.

1. Select **File/Page Setup**.
2. Select **Layout** and set Header and Footer as 0.
3. Select the **Margins** tab page. Select Left for Gutter Position and adjust the values of Top, Bottom, Left, and Right.

NOTE

If the warning prompt as shown in **Figure B-3** appears before printing, click **Ignore** to continue the printing.

Figure B-3 Warning prompt before printing

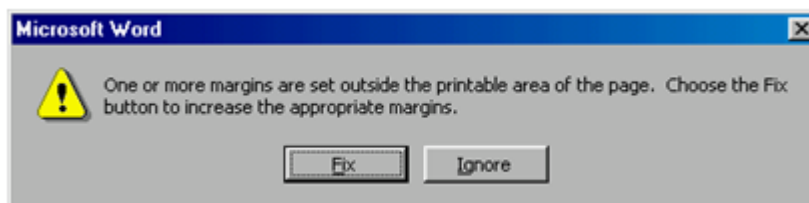

After the page setup has been made correctly, save it for future use. This page setup is only necessary for the first time you use the template to print the labels.

Requirements on Feeding the Printer

Different from the ordinary paper, the label paper is composed of two pages. No matter which model of the printer you are using, feed in the labels one after another by hand. Never use the auto-feed mode in order to avoid jamming the labels. Different models of printers may have different feeding modes, make sure to feed in the labels correctly.

Different models of printers may have different feeding modes, make sure to feed in the labels correctly.

Requirements on the Printed Label

Make sure that the printed labels satisfy the following requirements:

- All the printouts must be on the label, and nothing should be printed on the bottom page of the label.
- Contents in the cells should be aligned in the center. In a single-line printout, the dividing lines and the mark "To:" should not be covered by the printed characters.
- When the cells are merged and the printouts are made in multiple lines, avoid covering the mark "TO:" when printing the texts the space bar to move the printing contents to the next line.

B.1.4 Writing Labels

Writing Tools

To make sure the printouts are clear and legible, use the black oiliness markers instead of ball-pens to write the labels.

In special cases, black ball-pens are allowed, although not recommended. Compared with ball-pens, oiliness markers are better. When writing with the ball-pen, take care not to leave the oil on the label, which may contaminate the label and blur the words.

 **NOTE**

The delivered marker has two nibs. Make sure to use the smaller nib to write the labels.

Font

For the sake of easy recognition and good looking, the font in handwriting should be close to the standard typeface (Times New Roman) as much as possible. [Table B-1](#) shows the standard typeface.

Table B-1 Standard Typeface for Handwriting

0	1	2	3	4	5	6	7	8
9	A	B	C	D	E	F	G	H
I	J	K	L	M	N	O	P	Q
R	S	T	U	V	W	X	Y	Z

Write the characters in proper size. The characters should be clear, distinct, and tidy.

Writing direction: The direction is as shown in [Figure B-4](#):

Figure B-4 Writing direction of the characters on the label

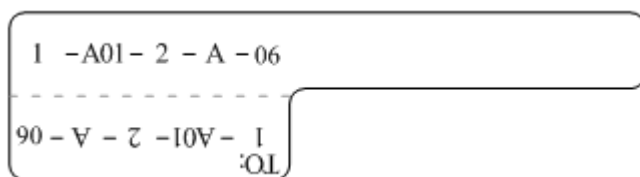

B.1.5 Affixing Labels

After printing or writing the label, remove the label from the bottom page and affix it to the signal cable, or the identification plate of the power cable. Method of affixing Labels:

Label for Signal Cables

- Choose the place to affix labels.
The label is affixed 2 cm from the connector on the signal cable. In special cases, for example, to avoid cable bent or affecting other cables, other positions are allowed to affix the labels. The rectangle part with characters is attached rightward or downward, as shown in [Figure B-5](#). The details are as follows:
 - The identification card is to the right of the cable in vertical cabling.
 - The identification card should be downward when you lay out the cable horizontally.

Figure B-5 Text Area of the Label

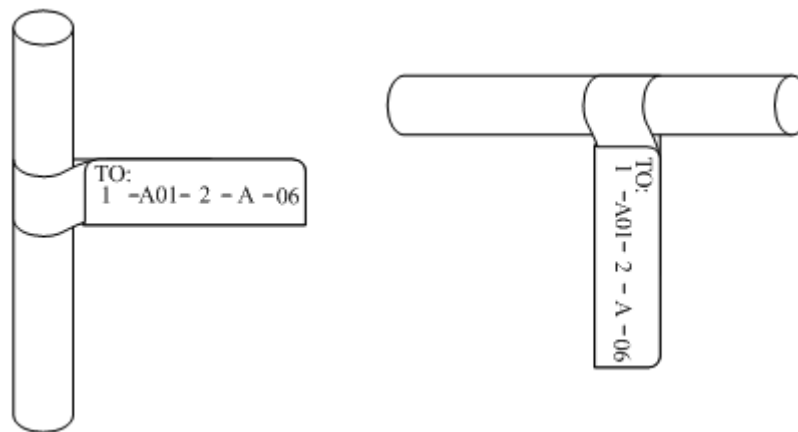

- Procedure for affixing labels
[Figure B-6](#) shows the methods and procedures for affixing labels.

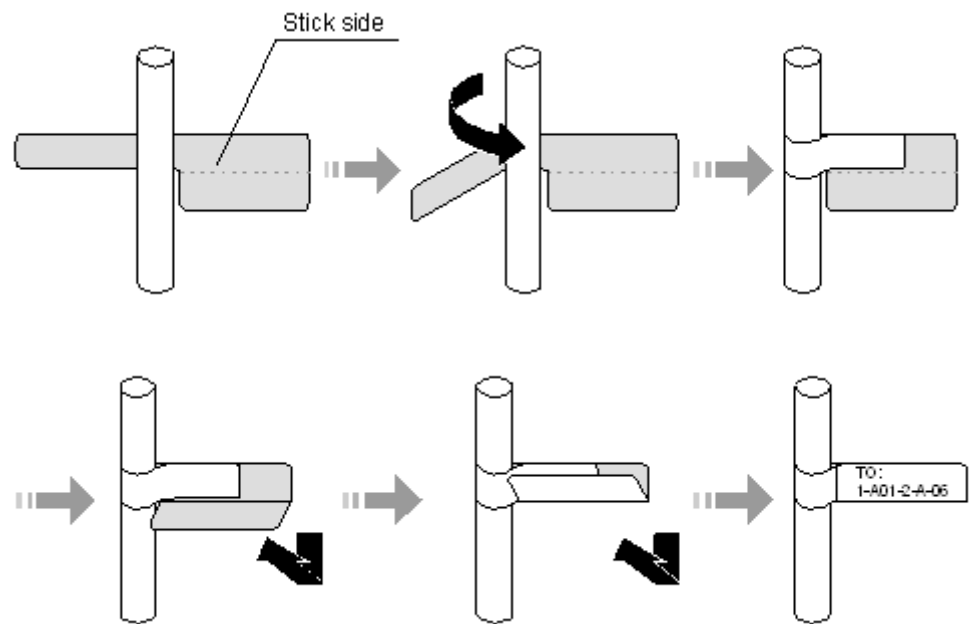
Figure B-6 Label for Signal Cables

Power Cable Label

Remove the label from the bottom page, and then affix it to the identification plate on the cable tie. Remove the label from the bottom page, and then affix it to the identification plate on the cable tie. The label should be stuck to the rectangular flute, and should be stuck to only one side of the identification plate. The cable ties are bundled at 2 cm from the connectors, and other positions are allowed in special circumstances.

Cable ties should be bound on both ends of a cable. After the bundling, the finished identification plate should be on top of the cable in horizontal cabling, or on the right side of the cable in vertical cabling, as shown in [Figure B-7](#). The details are as follows:

- The identification card is to the right of the cable in vertical cabling.
- The identification card is on the top of the cable in horizontal cabling. Make sure the label is facing out.

Figure B-7 Binding the Label for the Power Cable

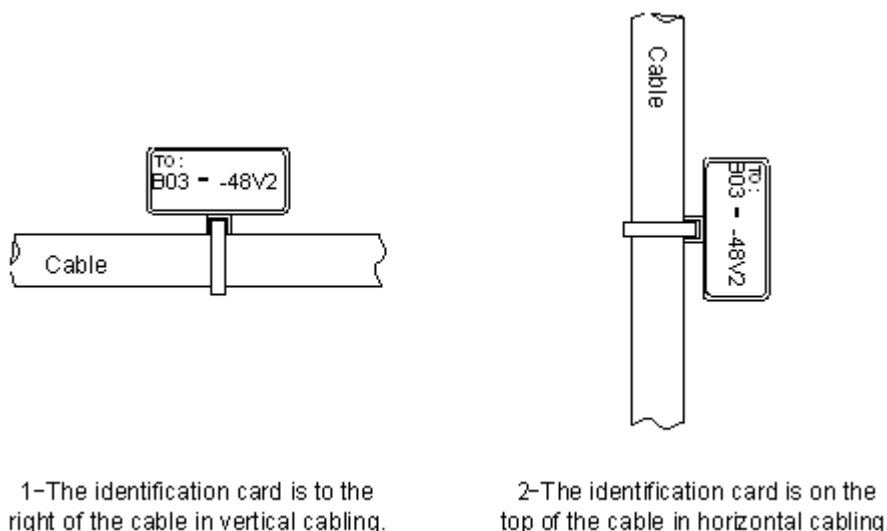

B.1.6 Contents of Engineering Labels

Contents of Labels for Power Cables

Labels for power cables are only affixed on one side of the identification plates. On the labels, there is information (the part after the mark "TO:") about the location of the device on the other end of the cable, like the location of control cabinet, distribution box or power socket.

Contents of Labels for Signal Cables

The two sides of the label affixed on the signal cable carry information about the location of the ports connected to both ends of the cable. **Figure B-8** shows the information on both sides of the labels affixed to the signal cables.

- Area 1 contains the location information of the local end of the cable.
- Area 2 (with the mark "TO:") contains the location information of the opposite end of the cable.
- Area 3 has been folded up inside the label.

Figure B-8 Printed parts on the label for signal cables

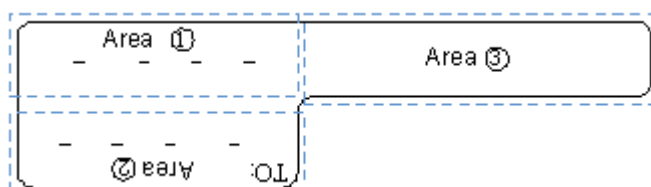

Seen from the cabling end of the equipment, the text part of the label is on the right side of the cable. The side with "TO:" that is facing outside carries the location information of the opposite end; and the other side carries the location information of the local end.

Therefore, the information in Area 1 at one end is the same as the information in Area 2 at the other end of the cable. In other words, the local information at one end is called the opposite information at the other end.

B.1.7 Precautions for Using Engineering Labels

When using labels, note the following:

- When printing, writing, or affixing labels, you should keep the labels clean.
- Since the label paper is made of moistureproof and waterproof material, ink-jet printers and ink pens are forbidden for printing and writing labels.
- Labels should be affixed tidily and gracefully. New-type labels are strip-shaped. If they are pasted at incorrect locations or in wrong directions, the appearance of the device is affected.
- Power cable ties should be bundled in the same position of power cables, with identification plates on the same side.
- The positions of “up”, “down”, “left” or “right” are all based on the viewpoint of the engineering person who works on the label.

B.2 Engineering Labels for Optical Fibers

This describes the engineering labels for optical fibers, including the labels for the optical fibers between devices and the labels for the optical fibers between a device and an ODF.

These labels are affixed to the optical fibers that connect the optical interfaces on the boards in a chassis, or on the device boxes. There are two types of labels for optical cables:

- One is for the fiber that connects the optical interfaces on two devices.
- The other is for the fiber that connects the device and the ODF.

B.2.1 Labels for the Optical Fibers Connecting Devices

B.2.2 Labels for the Optical Fibers Connecting the Device and an ODF

B.2.1 Labels for the Optical Fibers Connecting Devices

Meaning of the Label

Table B-2 lists information on both sides of the labels affixed to the optical fibers that connect two devices.

Table B-2 Information on labels affixed to the fiber between two devices

Content	Meaning	Example
MN-B-C-D-R/T	MN: cabinet number	M: The cabinet rows from front to back are numbered from A to Z. N: The cabinet columns from left to right are numbered from 01 to 99. For example, A01 is the cabinet in Row A and Column 01.

Content	Meaning	Example
	B: chassis number	Numbered in bottom-up order with two digits, for example, 01.
	C: physical slot number	Numbered in the top-bottom and left-right order starting from 01. For example, A01 is the slot with number 1.
	D: optical interface number.	Numbered with two digits in up-bottom and left-right order. For example, 1 is the second optical interface.
	R: Receiving interface T: optical transmitting interface	-
MN-B-C-D-R/T	MN: Cabinet number	M: The cabinet rows from front to back are numbered from A to Z. N: The cabinet columns from left to right are numbered from 01 to 99. For example, A01 is the cabinet in Row A and Column 01. Numbered in bottom-up order with two digits, for example, 01.
	B: chassis number	-
	C: physical slot number	Numbered in up-bottom and left-right order with two digits starting from 01. For example, A01 is the slot with number 1.
	D: optical interface number.	Numbered with two digits in up-bottom and left-right order. For example, 01 is the number 1 optical interface.
	R: Optical receiving interface T: optical transmitting interface	-

Example of the Label

Figure B-9 shows the label on the cable.

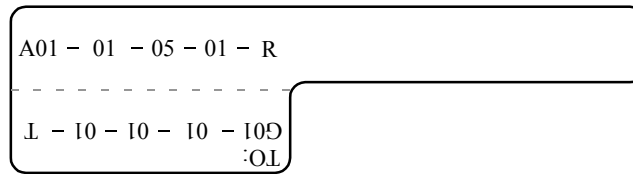
Figure B-9 Example of the label on the optical fiber between two devices

The meaning of the labels is listed in [Figure B-9](#).

- “A0-01-05-01-R” indicates that the local end of the optical fiber is connected with the optical receiving interface 01 on slot 5, chassis 01 in the cabinet on row A, column 01 in the machine room.
- “G01-01-01-01-T” indicates that the opposite end of the optical fiber is connected with Optical Transmitting Interface 01 on Slot 01, Chassis 01 in the cabinet on Row G, Column 01 in the machine room.

B.2.2 Labels for the Optical Fibers Connecting the Device and an ODF

Meaning of the Labels

[Table B-3](#) shows the information on both sides of the labels affixed to the optical fiber that connects the device and the ODF.

Table B-3 Information on labels affixed to the fiber between the device and the ODF

Content	Meaning	Example
MN-B-C-D-R/T	MN: cabinet number	For example, A01.
	B: chassis number	Numbered in bottom-up order with two digits, for example, 01.
	C: physical slot number	Numbered in bottom-up order with two digits, for example, 01.
	D: optical interface number.	Numbered with two digits in up-bottom and left-right order. For example, 01.
	R: Optical receiving interface T: optical transmitting interface	-

Content	Meaning	Example
ODF-MN-B-C-R/T	MN: row number and column number of an ODF	M: The cabinet rows from front to back are numbered from A to Z. N: The cabinet columns from left to right are numbered from 01 to 99. For example, G01 is the ODF of Row G and Column 01.
	B: row number of the terminal device	Range from 01 to 99, for example, 01-01.
	C: row number of the terminal device	
	R: Optical receiving interface T: optical transmitting interface	-

Example of the Label

Figure B-10 shows the label on the cable.

Figure B-10 Example of the label on the optical fiber between the device and the ODF

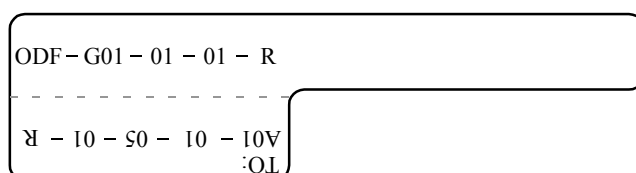

Meaning of the label in **Figure B-10**

- “ODF-G01-01-01-R” indicates that the local end of the optical fiber is connected with the optical receiving terminal on row 01, column 01 of the ODF in row G, column 01 in the machine room.
- “A01-01-05-01-R” indicates that the opposite end of the optical fiber is connected with Optical Receiving Interface 1 on Slot 01, chassis 01 in the cabinet on Row A, Column 01 in the machine room.

B.3 Engineering Labels for Network Cables

This describes the applicable ranges and contents of the engineering labels for network cables and gives instances.

Applicable Ranges

The labels can be applied to Ethernet cables.

Label Content

Table B-4 shows the information on both sides of the labels affixed to the Ethernet cables.

You can also decide the label content according to the actual environment. If the device is not installed in the cabinet, you can remove the cabinet number.

Table B-4 Information on the Ethernet cables

Content	Meaning	Example
MN-B-C-D	MN: cabinet number	For example, A01 is the first cabinet in row A.
	B: chassis number	Numbered in the bottom-up order with two digits, for example, 01.
	C: physical slot number	Numbered with two digits in bottom-up and left-right order. For example, 01.
	D: network port number	Numbered in the up-bottom and left-right orders. For example, 01.
MN-Z	MN: cabinet number	For example, B02 is the second cabinet in Row B.
	Z: Location number	Fill in the valid location number of the terminal device on site. If the cable is connected to a router in a cabinet, the serial numbers of the cabinet, the chassis, and the Ethernet interface of the router should be specified. For example, B02-03-12. If the cable is connected to the Network Management Station (NMS), specific location of the NMS should be given.

The contents of the labels for the network cables connecting hubs and routers or agents and the network cables for other purposes should be specified according to actual connections. The details are as follows:

- For the network cable connecting a hub and router, the label on the hub end should indicate the numbers of the chassis and cabinet where the hub resides, and the serial number on the hub. The label on the router end should indicate the number of the chassis and cabinet where the router locates. In case it is a stand-alone router, specific position of the router should be provided.
- For the network cable connecting a hub and an agent or a terminal, the label on the agent or terminal end should contain the serial number of the network interface. The definitions of the cabinet number and chassis number are the same as those described in Table D-4.
- If it is a stand-alone hub without any cabinet or chassis, the label should contain specific location information that identifies the hub.

The serial number on the hub, the network interface number of the agent or terminal, and the location of the stand-alone router should be specified according to actual connections.

Label Example

Figure B-11 shows the label on the cable.

Figure B-11 Example of the label on network cables

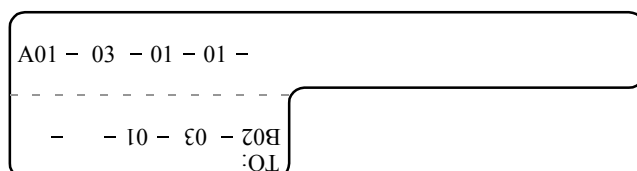

Meaning of the label in **Figure B-11**.

- “A01-03-01-01” indicates that one end of the network cable is connected to network interface 01 of slot 01, chassis 03 of the cabinet on row A, column 01 in the equipment room.
- “B02-03-01” indicates that another end of the network cable is connected to network interface 01, chassis 03 of the cabinet on row B, column 02 in the equipment room. No slot number.

B.4 Engineering Labels for Trunk Cables

This describes the engineering labels for trunk cables, including the labels for the cables between devices and the labels for the cables between a device and an MDF.

There are two types of labels for trunk cables:

- Labels for the cables between devices. For example, the label for the cable between a trunk board and a built-in transmission device and the label for the cable between two trunk boards. Attach labels to both ends of the cable to indicate the locations of the cable on both devices or on both trunk boards of a device.
- Labels for the cables between the device and a DDF. Attach labels to both ends of the cable to indicate the locations of the cable on the device and DDF.

The trunk cables are 75Ω/120Ω E1 cable, 100Ω T1 cable, 34M, 45M, 140M, and 155M cables, and 120Ω to 75Ω trunk cables.

B.4.1 Engineering Labels for Trunk Cables Between Devices

B.4.2 Engineering Labels for Trunk Cables Between the Device and a DDF

B.4.1 Engineering Labels for Trunk Cables Between Devices

Meaning of Engineering Labels for Trunk Cables Between Devices

Table B-5 shows the engineering labels for trunk cables between devices.

Table B-5 Contents of engineering labels for trunk cables between devices

Content	Meaning	Example
MN-B-C-D-R/T	MN: cabinet number	For example, A01.
	B: chassis number	Numbered in the bottom-up order with two digits, for example, 01.
	C: physical slot number	Numbered in the left-right and top-bottom order with two digits, for example, 01.
	D: interface number	Numbered with two digits in the top-bottom and left-right order. For example, 01.
	R: optical receiving interface, T: optical transmit interface.	-
MN-B-C-D-R/T	MN: cabinet number	For example, A01.
	B: chassis number	Numbered in the bottom-top order with two digits, for example, 01.
	C: physical slot number	Numbered in the left-right and top-bottom order with two digits, for example, 01.
	D: interface number.	Numbered with two digits in the top-bottom and left-right order. For example, 01.
	R: optical receiving interface, T: optical transmit interface.	-

Example of the Label

Figure B-12 shows the label on the cable.

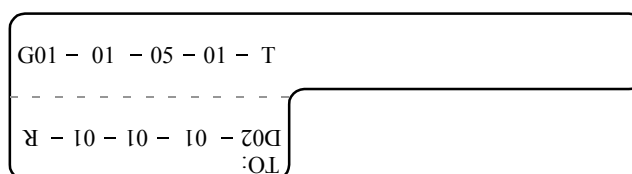
Figure B-12 Engineering labels for trunk cables between devices

Meaning of the label in **Figure B-12** is as follows:

- “G01-01-05-01-T” indicates that the local end of the trunk cable is connected to transmitting interface 01 on slot 05, chassis 01 in the cabinet on row G, column 01 in the equipment room.
- “D02-01-01-01-R” indicates that the opposite end of the trunk cable is connected to receiving interface 01 on slot 01, chassis 01 in the cabinet on row D, column 02 in the equipment room.

B.4.2 Engineering Labels for Trunk Cables Between the Device and a DDF

Meaning of the Engineering Labels for Trunk Cables Between the Device and a DDF

Table B-6 shows the engineering labels for trunk cables between the device and a DDF.

Table B-6 Contents of the labels for trunk cables between the device and a DDF

Content	Meaning	Example
MN-B-C-D-R/T	MN: cabinet number	For example, A01.
	B: chassis number	Numbered in the bottom-top order with two digits, for example, 03.
	C: physical slot number	Numbered in the left-right and top-bottom order with two digits, for example, 01.
	D: interface number	For example, 01.
	R: optical receiving interface, T: optical transmit interface.	-
DDF-MN-B-C-D/R/T	MN: row number and column number of a DDF	M: The rows of cabinets from front to back are numbered from A to Z. N: The columns of cabinets from left to right are numbered from 01 to 99. For example, G01 is the DDF of row G and column 01.
	B: row number of the terminal device	Range: 01 to 99 For example, 01-01.
	C: row number of the terminal device	

Content	Meaning	Example
DDF-MN-B-C-D/R/T	R: optical receiving interface, T: optical transmit interface.	Usually, a DDF is marked with "A", which indicates that the DDF terminal is connected to an optical network device or "B", which indicates that the DDF terminal is connected to a switching device.

Example of the Label

Figure B-13 shows an example of the label.

Figure B-13 Engineering labels for trunk cables between the device and a DDF

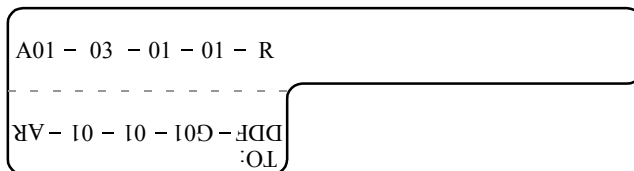

Meaning of the label in Figure B-13 is as follows:

- “A01-03-01-01-R” indicates that the local end of the trunk cable is connected to receiving interface 01 on slot 01, chassis 03 in the cabinet on row A, column 01 in the equipment room.
- “DDF-G01-01-01-AR” indicates that the opposite end of the trunk cable is connected to the receiving interface on row 01, column 01 of the DDF in row G, column 01 in the equipment room.

B.5 Engineering Labels for User Cables

This describes the applicable ranges and contents of the engineering labels for user cables and provides examples.

Attach labels to both ends of the cable to indicate the locations of the cable on the device and MDF.

Meaning of the Engineering Labels for User Cables

Table B-7 shows the contents of the labels.

Table B-7 Contents of the engineering labels for user cables

Content	Meaning	Example
MN-B-C-D	MN: cabinet number	For example, A01 is the first cabinet in row A.
	B: frame number	Numbered in the bottom-top order with two digits, for example, 03.

Content	Meaning	Example
	C: physical slot number	Numbered with two digits in the top-bottom and left-right order. For example, 01.
	D: cable number	Numbered with two digits in the top-bottom and left-right order. For example, 01.
MDF-MN-B-C	MN: row number and column number of the MDF	M: The rows of cabinets from front to back are numbered from A to Z. N: The columns of cabinets from left to right are numbered from 01 to 99. For example, G01 is the MDF of row G and column 01.
	B: row number of the terminal device	Ranges from 01 to 99, for example, 01.
	C: column number of the terminal device	

Example of the Label

Figure B-14 shows an example.

Figure B-14 Example of labels for user cables

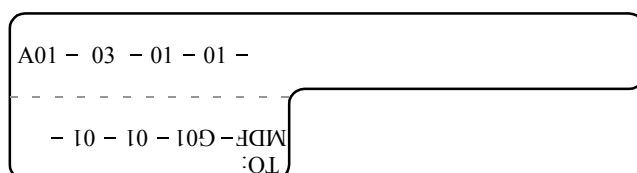

The meaning of the label in Figure B-14 is as follows:

- “A01-03-01-01” indicates that the local end of the user cable is connected to port 1 of on slot 1, chassis 03 of the cabinet on row A, column 01 in the equipment room.
- “MDF-G01-01-01-AR” indicates that the opposite end of the user cable is connected to the terminal on row 01, column 01 of the MDF in row G, column 01 in the equipment room.

B.6 Engineering Labels for Power Cables

This describes the engineering labels for power cables, including DC and AC power cables.

B.6.1 Engineering Labels for DC Power Cables

B.6.2 Engineering Labels for AC Power Cables

B.6.1 Engineering Labels for DC Power Cables

The labels are affixed to the DC power cables that provide power supply for cabinets, including the -48 V, PGND, and BGND cables. Here, the DC power cables also include power cables and protection grounding cables.

The labels for DC power cables are affixed to one side of the identification plates on cable ties. For details of the labels, see [Table B-8](#).

Table B-8 Contents of the label

Content	Meaning
MN(BC)– B--48Vn	MN(BC): BC is written right under MN. B: chassis number, numbered in the bottom-top order with two digits, for example, 01.
MN(BC)–B- BGND	N: power socket number , numbered as 1 to 3 in the bottom-top and left-right orders.
MN(BC)–B- PGND	On the loaded cabinet side, only MN is used to identify the cabinet. On the power cabinet side, MN identifies the row and column number of the power distribution equipment like a control cabinet and distribution box, and BC identifies the row and column number of the -48 V connector. If there is no row number or column number, or the connector can be identified without them, BC can be omitted. It is unnecessary for BGND and PGND to identify the row and column number.

The label only carries location information about the destination direction of the power cable while information of the local end is not necessary. That is, the label only carries location information about the opposite equipment, the control cabinet, or the distribution box. Table D-8 lists the information on two -48 V power supplies on the label. The information on other DC voltages, such as 24 V and 60 V should be given in similar methods.

Make sure that labels are affixed in the correction direction. That is, after the cable ties are bundled onto the cable, the identification plates with the labels should face up, and the text on the labels in the same cabinet should be in the same direction. For details, see [Table B-8](#).

Figure B-15 Example of the labels for DC power cables

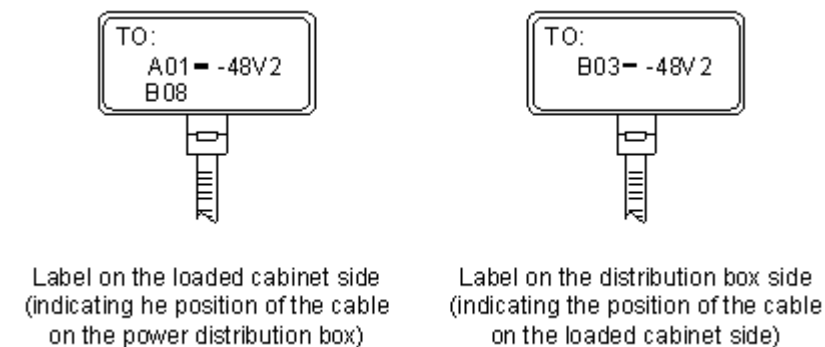

The meaning of the label in [Figure B-15](#) is as follows:

- On the loaded cabinet side, the label “A01/B08--48V2” on the cable indicates that the cable is -48 V DC supply, which is from the eighth connector on row B of -48 V bus bar in the cabinet on row A, and column 1 in the equipment room.

- On the distribution box side, the label “B03--48V2” indicates that the cable is -48 V DC supply, connected to DC power socket 2 on row B, column 03 in the equipment room.

 **NOTE**

In the power distribution box or the first power cabinet of a row in a transmission equipment room, every terminal block on the -48 V connector bar has a numeric identification. For example, in the above label of “A01/B08--48V2”, “08” (or sometimes “8”) is the numeric identification of the terminal block.

PGND and BGND are two copper bars, on which the terminal blocks are short-circuited, therefore which terminal is connected makes no difference. It is only necessary to give the row and column of the power distribution box, instead of giving the specific serial number of the terminal block on the copper bar. For example, if the label on the loaded cabinet side is “A01-BGND”, it means that the power cable is a BGND that connects BGND copper bar in the power distribution box on Row A, Column 01 in the machine room. Information on the labels for PGND cables should be given in a similar way.

B.6.2 Engineering Labels for AC Power Cables

The labels are affixed to both ends of an AC power cable that provides AC power supply to cabinets, including 220 V, PGND, and BGND cables. The 220 V AC cables and related PGND and BGND cables are covered with insulating sheath, so the labels need to contain only the words of “AC” and the cabinet numbers.

The labels for AC power cables are affixed to one side of the identification plates on cable ties. For details, see [Table B-9](#).

Table B-9 Label content

Content	Meaning
MN-(B)-ACn	<p>MN: serial number of the cabinet or the socket where the power is led in</p> <p>B: chassis number, numbered in the bottom-top order with two digits, for example, 01.</p> <p>n: power port number, numbered as 1 to 3 in bottom-top and left-right order.</p> <p>Serial number of the socket where the power is led in: the location of the socket is marked out according to the actual situation. If the sockets can be identified by row numbers and column numbers, they can be numbered following the same rule for the cabinets. If the sockets cannot be identified by rows and columns, specify the detailed locations to avoid confusing with other sockets.</p>

The label only carries location information about the opposite equipment and the power socket, while information about the local end is not necessary.

Make sure that labels are affixed in correct direction. That is, after the cable ties are bundled onto the cable, the identification plates with the labels should face up, and the text on the labels in the same cabinet should be in the same direction, as shown in [Figure B-16](#).

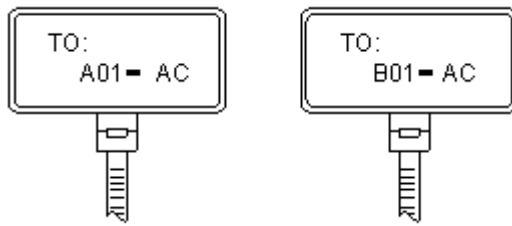
Figure B-16 Labels for AC power cables

Meaning of the label in **Figure B-16**.

- On the loaded cabinet side, the label “A01-AC” indicates that the power cable is connected to the socket of Row A and Column 01 in the machine room.
- On the power socket side, the label marked with “B01-AC1” indicates that the power cable is connected to AC power socket on Row B, Column 01 in the machine room.